

DIGITAL TRUNKING
**Desktop/Mobile
Radio Scanner**

OWNER'S MANUAL

WS1065



WHISTLER

TABLE OF CONTENTS

Contents

Introduction	4
What is Object Oriented Scanning?	4
Package Contents	5
Scanning Legally	5
Features	6
Setup	7
Antenna	7
External Antenna	8
Desktop Operation	9
Mount Installation	9
Headphones and Speakers	10
Listening Safely	10
AC Adapter	11
DC Power Cable	12
Understanding the Keypad	13
Turning on the Scanner	15
Understanding the Display Icons	16
Programming	17
Programming Cables	17
RadioReference.com	18
Scanner Cloning	19
Text Entry	21
Scanning	23
Objects and Scan Lists	23
Monitoring	25
Scanning	27
Priority Scan	29
Favorites Scan List	30
Object Lockout	31
Multi-Site Mode (Motorola and P25)	33
Home Repeater AutoMove (LTR)	34

TABLE OF CONTENTS

Searching	35
Limit Search Object (LMIT).....	37
Service Search Object (SRVC).....	39
Spectrum Sweeper Object (SWPR)	41
Weather Features	43
SAME Standby	43
Configuring	46
Using V-Scanner Storage	49
Initializing Global Settings	51
Initializing to Factory Defaults.....	52
Configuration Shortcuts.....	53
Manual Programming Guide	54
Conventional Objects (CONV).....	55
Trunking System (TSYS) Object	57
Talkgroup (TGRP) Object	59
Duplicating Objects	61
No Scan List	61
Deleting Objects.....	62
Memory Usage.....	62
Hit Counter	63
Specifications	64
Frequency Coverage	67
Maintenance.....	68
Birdie Frequencies	68
PC Interface	69
FCC Statement	71
Limited Warranty.....	72

INTRODUCTION

WELCOME

Thank you for choosing a Whistler product. We are dedicated to providing products that represent both quality and value. Please read the user manual carefully before using this product. If you have additional questions, please visit the FAQ page on our website at www.whistlergroup.com or call toll free 800-531-0004, 8am to 5pm CT, Monday through Friday to speak to a Customer Service Representative.

Introduction

Scanning technology has changed dramatically over the years. The WS1065 scanner with Object Oriented User Interface is designed to help the hobbyist build a collection of channels to scan:

- Start small and expand
- Organize channels and talkgroups
- Remove unwanted channels and talkgroups

What is Object Oriented Scanning?

Programming scanning receivers can be challenging, but object-oriented programming simplifies the process by using common conventions for scanning concepts that have common characteristics.

A **Scannable Object** is any defined item that can be scanned or monitored, including:

- Conventional, non-trunked radio frequencies
- Talkgroups used on a trunked radio system
- Radio services
- Defined searches

Because scannable objects are defined by the same basic elements, the **Object Oriented User Interface (OOUI)** is designed to simplify scanning by managing all scannable objects similarly. When you learn how to program one type of object, you can program other types of scannable objects as well.

SCANNING LEGALLY

Package Contents

- Scanner
- Antenna
- PC/IF Cable
- AC adapter
- DC cable with fuse
- Screws (2)
- Mounting bracket
- DIN sleeve
- Keys (2)
- Rubber washers (2)
- Lock washers (2)
- Rubber feet (5)
- Knobs (2)
- User's Guide
- QuickStart Guide

Scanning Legally

Your scanner covers frequencies used by many different groups including police and fire departments, ambulance services, government agencies, private companies, amateur radio services, military operations, pager services, and wireline (telephone and telegraph) service providers. It is legal to listen to almost every transmission your scanner can receive. However, there are some transmissions you should never intentionally listen to.

These include:

- Telephone conversations (cellular, cordless, or other means of private telephone signal transmission)
- Paging transmissions
- Any intentionally decoded scrambled or encrypted transmissions

According to the Electronic Communications Privacy Act (ECPA), you are subject to fines and possible imprisonment for intentionally listening to, using, or divulging the contents of such a transmission unless you have the consent of a party to the communication (unless such activity is otherwise illegal). This scanner has been designed to prevent reception of illegal transmissions. This is done to comply with the legal requirement that scanners be manufactured

FEATURES

so as to not be easily modifiable to pick up those transmissions.

Do not open your scanner's case to make any modifications that could allow it to pick up transmissions that are illegal to monitor. Doing so could subject you to legal penalties. We encourage responsible, legal scanner use. In some areas, mobile use of this scanner is unlawful or requires a permit. Check the laws in your area. It is also illegal in many areas to interfere with the duties of public safety officials by traveling to the scene of an incident without authorization.

Features

- Intuitive Object Oriented User Interface
- Context Sensitive Help
- Scan List
- V-Scanner Technology - Save complete backup radio configurations, up to 21 versions.
- SKYWARN™ Storm Spotter Function
- SAME and All Hazards Weather Alerting
- Multi-System Trunking
- Exclusive Automatic Adaptive Digital Tracking - Adapts to multipath or fading for P25 digital systems
- Exclusive Digital AGC
- LTR Home Repeater AutoMove
- Subaudible Squelch Decoder
- Spectrum Sweeper – Advanced feature for finding active frequencies.
- Zeromatic – Enhances the scanner's ability to lock on to the actual center frequency of a search hit instead of an adjacent frequency.
- P25 NAC Functionality
- Alert LED and Audible alarms
- High Speed USB PC Interface
- Real-time Signal Strength Indicator
- Upgradeable CPU and DSP Firmware

INSTALLATION OF ANTENNA

Setup

Antenna

You scanner's antenna connects easily, or you can use a variety of antennas, such as an external mobile antenna or outdoor base station antenna.

To connect an external antenna, follow the installation instructions supplied with the antenna. Always use 50-ohm coaxial cable, such as RG-58 or RG-8 low-loss dielectric coaxial cable. You may also need a BNC adapter.

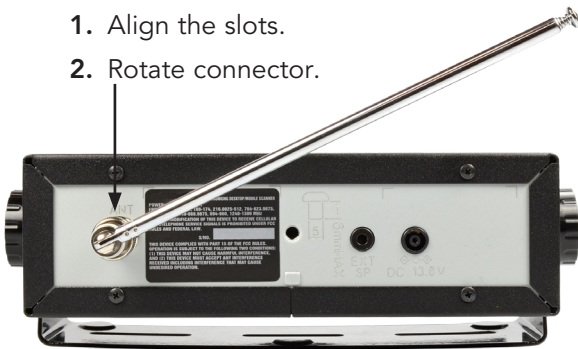

To connect the included antenna:

Your scanner's frequency sensitivity depends on its location and the antenna length. For best reception, adjust the antenna's length as follows:

FREQUENCY	ANTENNA LENGTH
25-54 MHz	Extend fully
108-174 MHz	Extend 4 segments
216-225 MHz	Extend 3 segments
225-406 MHz	Extend 2 segments
406-1300 MHz	Collapse fully

INSTALLATION OF ANTENNA

WARNING: Use extreme caution when installing or removing an outdoor antenna. If the antenna starts to fall, let it go! It could contact overhead power lines. If the antenna touches a power line, touching the antenna, mast, cable, or guy wires can cause electrocution and death. Call the power company to remove the antenna. DO NOT attempt to do so yourself.

WARNING: Outdoor antennas must be properly grounded to prevent static buildup and lightning damage. Article 810 of the National Electrical Code, ANSI/NFPA 70, provides information about proper grounding of the antenna mast, connection of coaxial cable to a lightning arrestor, size of grounding conductors, location of the lightning arrestor and connection of grounding conductors to grounding electrodes.

Additionally, disconnect your radio from the outdoor antenna during electrical storm activity to prevent damage. The diagram below provides an example of a proper antenna grounding system.

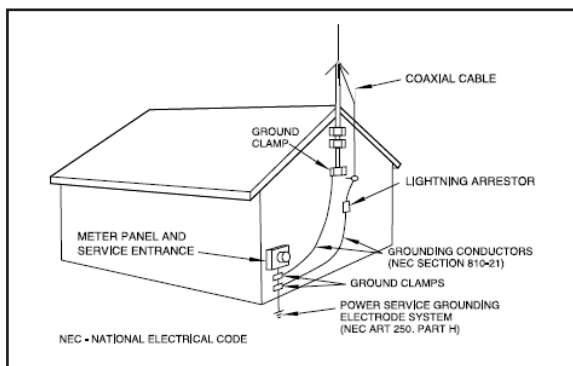

DESKTOP OPERATION

Desktop Operation

The mounting bracket works as a desktop stand when attached underneath the radio. Use the provided rubber feet to prevent sliding or scratching. Do not use the rubber feet if mounting permanently to a fixed surface. Extra pads are provided for additional stability.



1. Attach the adhesive rubber feet to the mounting bracket.
2. Attach the two adhesive rubber washers over the mounting holes, between the mounting bracket sides and the scanner's side holes.
3. Position the bracket with the two recessed feet toward the front of the scanner.
4. Use the two provided knobs to secure the scanner within the mounting bracket.

Mount Installation

Attach the bracket over the radio to suspend the scanner from above. Attach the bracket underneath the scanner to mount it on top of a flat surface. Your WS1065 also fits into the included DIN-E compatible sleeve for existing dashboard openings.

NOTE: In some cases, installation requires specialized tools and skills. If in doubt, seek assistance from a local car audio electronics installation shop, or a local two-way radio dealer.

Select a location that does not interfere with driving or with the deployment of your vehicle's air bags. Do not mount this or any other equipment where deployment of the air bags might cause it to be propelled towards passengers. If necessary, seek advice from your automotive dealer or service shop.

ACCESSORIES

Use the mounting bracket as a template to mark the locations for the two mounting screws.

Drill holes that are slightly smaller than the screws. Use caution not to damage wiring or components that are located behind the mounting surface.

Using the provided screws and lock washers, attach the mounting bracket to your vehicle.

Headphones and Speakers

You can plug headphones (not supplied) or an amplified speaker (not supplied) with a 1/8-inch (3.5 mm) mini-plug earphone or in the headphone jack on top of your scanner. This automatically disconnects the internal speaker.

NOTE: Use an amplified speaker with this scanner; Non-amplified speakers do not provide sufficient volume for comfortable listening.

Listening Safely

To protect your hearing, follow these guidelines when you use headphones:

Set the volume to zero before putting on headphones. With the headphones on, adjust the volume to a comfortable level.

Avoid increasing the volume after you set it. Over time, your sensitivity to a volume level decreases, so volume levels that do not cause discomfort might damage your hearing.

Avoid or limit listening at high-volume levels.

Prolonged exposure to high-volume levels can cause permanent hearing loss.

Wearing headphones while operating a motor vehicle can create a traffic hazard and is illegal in most areas. Even though some headphones let you hear some outside sounds when listening at normal volume levels, they still can present a traffic hazard. Exercise extreme caution!

EXTERNAL POWER

AC Adapter

You must use a power source that supplies 12-14.4 VDC and is rated for 600 mA. Its center tip must be set to positive and its plug must fit the scanner's DC 13.8V jack. The supplied DC power adapter meets these specifications. Using a DC adapter that does not meet these specifications could damage the scanner or the adapter.

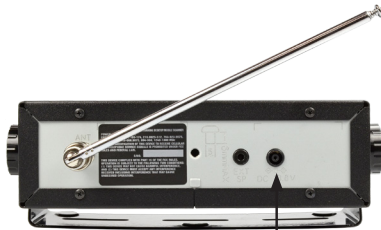

To Connect the AC Adapter

1. Plug the supplied AC adapter into the **DC 13.8V** jack.
2. Plug the AC adapter into your wall outlet.

WARNING: To prevent electric shock, do not use the AC adapter's polarized plug with an extension cord, receptacle, or other outlet unless you can fully insert the blades to prevent blade exposure.

EXTERNAL POWER

DC Power Cable

Connect the supplied DC power cable to a vehicle power source:

1. Disconnect your battery's negative (-) terminal.

NOTE: Disconnecting your battery may reset some devices in your vehicle, such as automotive audio systems, navigation systems, or alarm systems.

2. Route the supplied DC power cord between a power source and the mounting location for your scanner.
3. Ground the power cord's black wire to your vehicle's chassis.

NOTE: The grounding screw must make complete contact with the metal frame of your vehicle.

4. Connect the power cord's red wire to a voltage source that turns on and off with the ignition switch, such as a spare accessory terminal in your vehicle's fuse box.
5. Insert the power plug into the DC power jack on the rear of the radio.
6. Reconnect the cable to the negative (-) terminal of your vehicle's battery.

NOTE: If your vehicle's engine is running, you might hear electrical noise from the engine while scanning. This is normal.

WARNING: The DC power cord is equipped with an inline fuse. This fuse protects your scanner and your vehicle from damage in case of equipment malfunction or a short circuit. Do not remove the inline fuse holder from the DC power cord. If the fuse blows, replace it with a 2A fuse and apply power again. If the fuse blows again, check all wiring for short circuits, and check the radio for a malfunction.

KEYPAD

Understanding the Keypad



Your WS1065 features an easy-to understand backlit keypad.

F1 F2 F3	Referred to as "softkeys;" These keys activate functions currently displayed immediately above them.
FUNC	Function. Press and release the FUNC key first, and then press the next key.
DIM	Backlight, (FUNC + DIM locks the keypad)
MAN	Manual Mode monitors single objects.
SCAN	Scan Mode, (FUNC + SCAN launches Spectrum Sweeper)
TUNE	Direct tuning of any valid frequency, (FUNC + TUNE loads the most recently scanned frequency)
SRCH	Search Mode for service and conventional frequencies
ATT	Attenuator On/Off, (FUNC + ATT sets Global Attenuator On/Off)
PRI	Priority setting for current object, (FUNC + PRI Sets Priority Mode On/Off)

KEYPAD

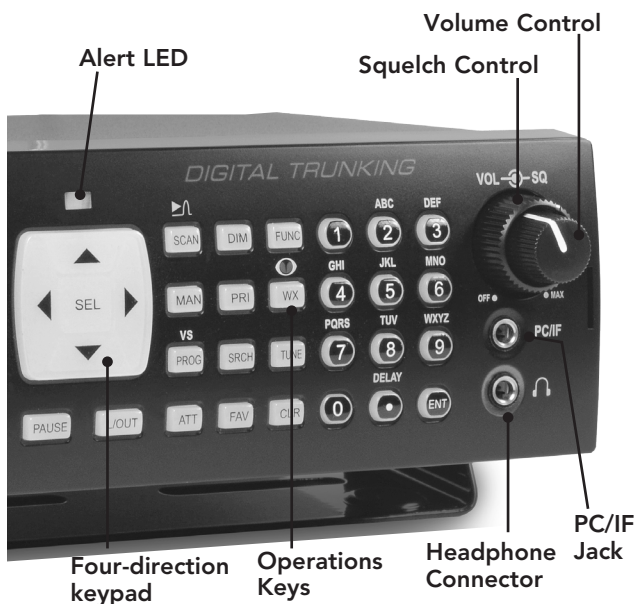

FAV	Favorites Scan Mode, FUNC + FAV adds the current object to the Favorites Scan List.
WX	Weather scan, (FUNC + WX activates Skywarn)
PROG	Program objects, (FUNC + PROG accesses V-Scanner)
L/OUT	Temporary Lockout (FUNC + L/OUT permanent lockout).
ENT	Enter
PAUSE	Pauses Scanning

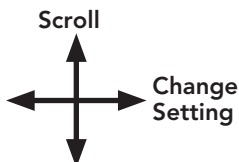

Four-direction keypad – Used to navigate through objects and menu items. For some menu items, the side buttons can be used to change settings. Press **SEL** to select the highlighted item.

TURNING ON SCANNER

Turning on the Scanner

The squelch and attenuator control scanner sensitivity. If squelch is set too low, the scanner may stop on noise or silence.

Note: Make sure the scanner's antenna is connected before you turn it on.

1. Turn the **SQUELCH** knob to about mid-position.
2. Turn the **VOLUME** knob to turn on the radio.
3. Turn **SQUELCH** down (counterclockwise) until you hear noise.
4. Turn **SQUELCH** up (clockwise) a little past where the noise stops. The higher the squelch is set, the stronger the signal required to break the squelch.



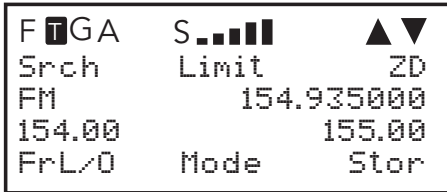

DISPLAY

Understanding the Display Icons

Your WS1065 features a high contrast, backlit Liquid Crystal Display (LCD).



The scanner uses the following top row of icons:

- F** The Function Key (FUNC) has been pressed. This acts as a "Shift" key.
- ** The scanner is currently receiving trunking control channel data.
- G** The attenuator is set for Global mode.
- A** The attenuator is currently active.
- S** The radio's squelch circuit is open.
- ** Signal meter indicating signal strength.
-  ** Indicate scan or search direction.

PROGRAMMING CABLES

Programming Cables

The simplest method for programming a new scanner is using a PC/IF cable, which is included with the scanner. The cable lets you use software provided by RadioReference.com and their constantly updated database to program your new scanner quickly and easily. RadioReference.com also provides a range of resources to help improve your overall scanning experience.

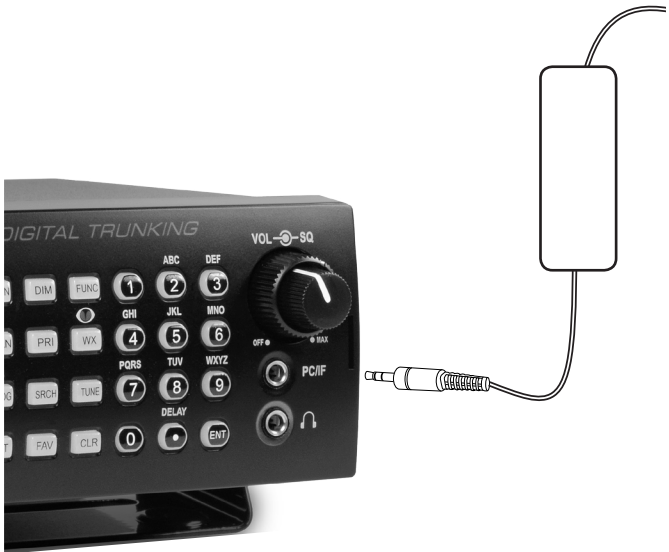

RADIO REFERENCE

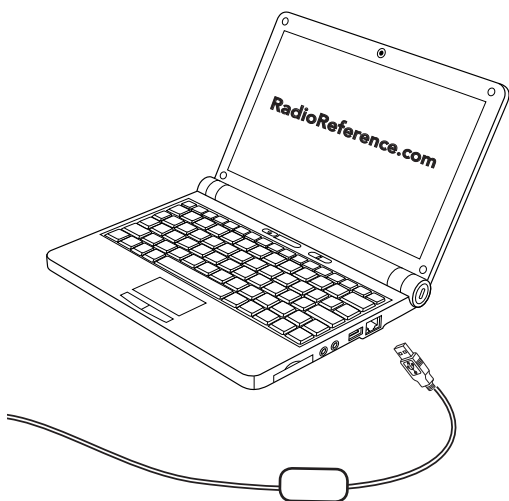

RadioReference.com
Your Complete Reference Source

www.radioreference.com

RADIOREFERENCE.COM IS THE WORLD'S LARGEST RADIO COMMUNICATIONS WEBSITE, WITH A COMPLETE FREQUENCY AND TRUNKED RADIO SYSTEM DATABASE. COME SEE WHAT FREE SERVICES WE HAVE TO OFFER TO THE COMMUNITY:



The RadioReference Database

Includes a complete frequency database, trunked radio system information, FCC license assignments, 10 Code lists, agency maps, files, downloads, and detailed information for most public safety, military, and local government communications systems.



The RadioReference Discussion Forums

Where over 120,000 members discuss radios, scanning, trunking, decoding, antennas, specialty radio topics, and location specific information.



The RadioReference Wiki

The most comprehensive reference source of radio communications reference information – the de-facto encyclopedia for the radio communications community.

CLONING

Scanner Cloning

If you have access to a compatible scanner that is already programmed for your area, you can transfer that scanner's programming using a standard stereo patch cord (not included), terminated with 1/8" male stereo plugs at each end.

The WS1065 is compatible with the following scanner models: PRO-106, PRO-197, PRO-651, PRO-652, GRE PSR-500, PSR-600, Whistler WS1040 and WS1065.



To clone a scanner:

1. Connect the two scanners at their **PC/IF** ports.
2. Turn on both scanners.
3. On the source scanner, press **PROG**.
4. Press the **GLOB** softkey.
5. Use the 4-direction keypad to locate the **Clone Send** option.
6. Press **SEL** to transfer data.

MANUAL PROGRAMMING



NOTE: Working memory and global settings are transferred but not V-Scanner folders. The target scanner's working memory will be overwritten.

In some cases, the CCDump output may interfere with cloning.

To turn off CCDump:

1. Press **PROG**.
2. Press **FUNC** and then the **GLOB** softkey.
3. Use the 4-direction keypad to locate the **CCDump** option and change the setting.
4. Press the **Save** softkey.

Manual Programming

Modern radio systems can be complex and challenging to program. If you choose to program your scanner manually, refer to the "Manual Programming Guide" on page 54.

TEXT ENTRY

Text Entry

Your scanner uses several text parameters, such as the tags that identify objects.

To enter a letter in a text field, press the number key below the letter, then press the number key that corresponds with the position of the letter.

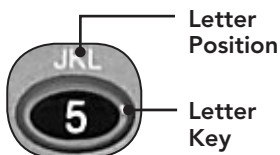

For example: K = **5 2**

Uppercase is the default; use the **FUNC** key as a shift key to type lowercase letters. For punctuation, refer to the following list.

Char	Press	Char	Press	Char	Press	Char	Press
A	21	a	2 (F) 1	1	11	\$	01
B	22	b	2 (F) 2	2	12	%	02
C	23	c	2 (F) 3	3	13	!	03
D	31	d	3 (F) 1	4	14	^	04
E	32	e	3 (F) 2	5	15	(05
F	33	f	3 (F) 3	6	16)	06
G	41	g	4 (F) 1	7	17	?	07
H	42	h	4 (F) 2	8	18	->	08
I	43	i	4 (F) 3	9	19	'	09
J	51	j	5 (F) 1	0	10	<-	00
K	52	k	5 (F) 2			.	0(F)1
L	53	l	5 (F) 3			-	0(F)2
M	61	m	6 (F) 1			#	0(F)3
N	62	n	6 (F) 2			_	0(F)4
O	63	o	6 (F) 3			@	0(F)5
P	71	p	7 (F) 1			+	0(F)6
Q	72	q	7 (F) 2			*	0(F)7
R	73	r	7 (F) 3			&	0(F)8
S	74	s	7 (F) 4			/	0(F)9
T	81	t	8 (F) 1			,	0(F)0
U	82	u	8 (F) 2				
V	83	v	8 (F) 3				
W	91	w	9 (F) 1				
X	92	x	9 (F) 2				
Y	93	y	9 (F) 3				
Z	94	z	9 (F) 4				

QUICK TEXT

Use the 4-direction keypad to move the cursor. Press **FUNC** and the 4-direction keypad to move the cursor to the beginning or end of the field.

Use **CLR** as a backspace key, or press **FUNC** and then **CLR** to clear the entire field.

QuickText

You can store up to 10 commonly used QuickText phrases for later use in text fields. Your scanner provides some common QuickText words, which you can keep or edit.

To edit QuickText:

1. Press **PROG**.
2. Press the **GLOB** softkey.
3. Scroll to one of the **QTX** items.
4. Press **▶** to edit the **QTX** entry.
5. Edit the text. To keep the cursor at the end of your quick text insert a dollar sign (\$).
6. Press the **DONE** softkey.
7. Press the **SAVE** softkey.

To insert QuickText:

1. Position the cursor in the text field.
2. Press the **QTX** softkey. The available QuickText phrases appear.
3. Use the 4-direction keypad to select a phrase and press **SEL**. (Shortcut: You may press the number that corresponds to the QuickText item).

Scanning

Objects and Scan Lists

Instead of channels and banks, scannable objects are assigned Object IDs and assigned to scan lists. The number of objects that can be grouped in a particular scan list is not limited, and objects can be assigned to multiple scan lists.

When programmed, your scanner provides two basic functions for scanning radio transmissions:

- Monitoring – Listening to a single object.
- Scanning – Checking multiple saved objects, stopping when a transmission is detected.

Additionally, you can combine different object types in any scan list, including a mix of trunked talkgroups and conventional frequencies. By default, every new object you create is mapped to Scan List 01.

NOTE: Objects are not moved into scan list(s). Instead, objects are mapped to scan lists, so that a single object can be assigned to multiple scan lists without using any additional scanner memory.

Your scanner provides 20 standard scan lists, one Favorites scan list, and a Skywarn scan list.

TIP: Consider how you plan to organize your objects for scanning. You can organize your scan lists geographically, assigning objects for your location in one list and objects for other locations in different lists. You can organize your scan lists by trunking system, assigning TGRP objects associated with specific trunked radio systems to separate lists. You can also organize your scan lists by object type, assigning CONV objects to one list and TGRP objects to another.

SCAN LIST

To name your scan lists:

1. Press **PROG**.
2. Press the **GLOB** softkey.
3. Scroll to **Scan Lists**.
4. Press **SEL**. The Scan Lists sub menu appears.
5. Scroll to the **Scan List** and press the **▶** key.
6. Scroll to the **Tag** field and press the **▶** key.
7. Edit the **Tag** text field.
8. Press the **Done** softkey.
9. Press the **Save** softkey.
10. Press the **Save** softkey again.

To assign objects to Scan Lists:

1. Open the object and locate the **Scan Lists** parameter.
2. Press **SEL** to toggle membership for that scan list. An asterisk (*) next to the scan list number indicates assignment.
3. Press the **Save** softkey.

To change the default Scan List:

1. Press **PROG**.
2. Press the **GLOB** softkey.
3. Scroll down to **Dflt ScanList**.
4. Press **SEL**.
5. Enter a new default scan list number:
 - 00 – Not scanned (NS)
 - 01-20 – Standard Scan Lists
 - 21 – The Favorites Scan List
 - 22 – The SKYWARN Scan List
6. Press the **Done** softkey.
7. Press the **SAVE** softkey.

MONITORING

Monitoring

Your scanner can monitor a single frequency or object.

To tune a frequency to monitor:

1. Press **TUNE**.
2. Press the **MODE** softkey to change the receive mode (AM, FM, au).
3. Use the number keys to enter a frequency.
4. Press **ENT** to make this the **TUNE** frequency. Next time you press **TUNE**, this frequency will load.

To monitor an object:

1. Press **MAN** to enter Manual mode.

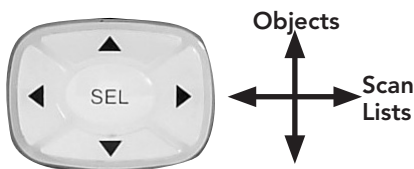

2. Use the 4-direction keypad to browse the objects in the current scan List and select an object to monitor. Only scan lists that contain objects appear when browsing.

Finding Stored Objects

The radio searches in the frequency, tag, or ID fields. When the scanner finds a matching object, you may press **MAN** to begin monitoring the object.

To find objects that are locked out:

1. Press **PROG**.
2. Press the **EDIT** softkey.
3. Press the **FIND** softkey.
4. Press the **L/Out** softkey.
5. Press the **NEXT** softkey to find the next locked out object.

STORED OBJECTS

To find objects by text string:

1. Press **PGM**.
2. Press the **EDIT** softkey.
3. Press the **FIND** softkey.
4. Press the **Text** softkey and enter the text string.
 - 4a. Press the **Qtxt** softkey to use QuickText. Press the ▼ to select one of the 10 Qtxt options. Press **SEL** to accept Qtxt selection.
5. Use the 4-direction keypad to scroll through available objects.
6. Press the **OK** softkey. Press the **Exit** softkey to cancel the Find operation.

To find objects by object type:

1. Press **PROG**.
2. Press the **EDIT** softkey.
3. Use the 4-direction keypad to scroll to the filter softkeys: **CONV**, **TGRP**, **TSYS**, **SRCH**, and **SWPR**.
4. Press the softkey for the object type.
5. Use the 4-directional keypad to scroll through available objects.

SCAN OBJECTS

Scanning

When scanning, the radio checks programmed scannable objects for transmissions, stopping when transmissions are received.

You can use lock out functions to skip specific objects, and you can make entire scan lists active or inactive.

To scan objects:

1. Press **SCAN**. The two rows under **Scanning** represent your scanner's scan lists (Top row = scan lists 1-10, bottom row = scan lists 11-20).

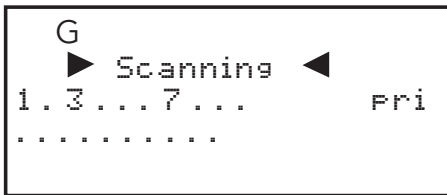

2. Numbers represent active scan lists, periods represent inactive scan lists. To toggle a list, press the corresponding number on the keypad. For 11-20, press **FUNC** and then the second number (**FUNC** + 3 = 13).

When the scanner receives a transmission, the object information appears on the screen.

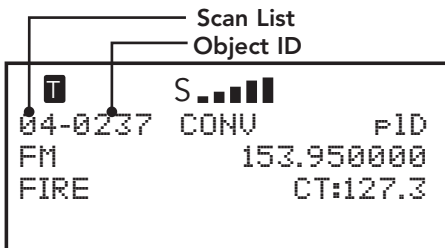

3. To pause the scanner on an active object, press **PAUSE**.
4. Press **PAUSE** or **SCAN** to resume scanning.

SCAN LISTS FROM GLOBAL SETTINGS

To enable Scan Lists from Global Settings:

1. Press **PROG** to enter Program Mode
2. Press the **GLOB** softkey.
3. Scroll to the Scan Lists parameter and press **SEL**.
4. Use the 4-direction keypad to toggle the scan list.
An asterisk (*) indicates that the scan list is enabled.
5. Use ◀ or ▶ to access the Enabled option
6. Use ◀ or ▶ to enable selected scan list.
7. Press the **SAVE** softkey.
8. Press **SAVE** again.

PRIORITY SCAN

Priority Scan

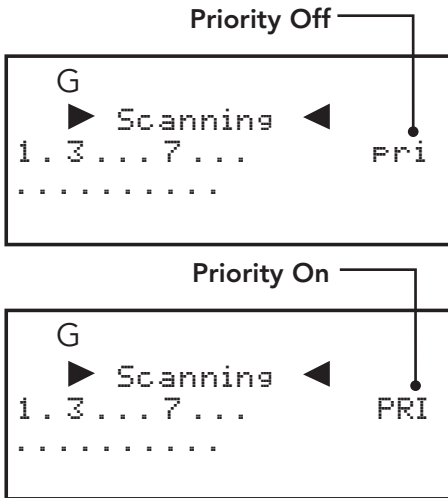

You can designate increased priority to certain objects:

- CONV – The scanner samples objects for activity more frequently.
- TGRP – The scanner checks the priority object first and during reply delays of non-priority objects.

To set priority for objects:

- While scanning, when the scanner stops for a transmission, press **PRI**.
Note: pID will change to PID indicating priority is set.
- In Manual or Program modes, browse to the object and then press **PRI**.
Note: pID will change to PID indicating priority is set.
- You can edit an object's Priority setting directly during programming.

To activate Priority Scan Mode:

While the radio is scanning, press **FUNC** and then press **PRI**. Repeat to cancel Priority Scan Mode.

NOTE: Priority sampling may cause brief muting of received audio if another object is active.

FAVORITES SCAN LIST

Favorites Scan List

To add an object to the Favorites Scan List, press **FUNC** and then **FAV** while the object is active.

When you press **FAV** later, your scanner suspends all scanning except for the Favorites Scan List.

To clear the entire FAV Scan List:

1. Press **PROG**.
2. Press the **GLOB** softkey.
3. Scroll to down to the **Clear FAV** menu item.
4. Press **SEL**. You will be asked to confirm the action.
5. Press the **Save** softkey.

OBJECT LOCKOUT

Object Lockout

Transmissions for locked out objects are ignored for all scan list. Four lockout types are available:

- Temporary – The object is locked out until the scanner is turned off. When the scanner is turned on again, temporary lockouts are removed. A flashing lowercase "l" indicates a temporary lockout.
- Permanent – The object is locked out until you unlock it. An uppercase "L" indicates a permanent lockout.
- Talkgroup Lockout – Used with wildcard TGRP objects. This locks out a specific talkgroup, but the wildcard TGRP remains active.
- Search Lockout – Lock out up to 250 undesired frequencies that are found during searches.

To lock out an object:

- While the object is active, press **L/OUT**.
- To apply permanent lockout, press **FUNC** and then **L/OUT**.
- To lock out a talkgroup, press the **TGL/O** softkey.

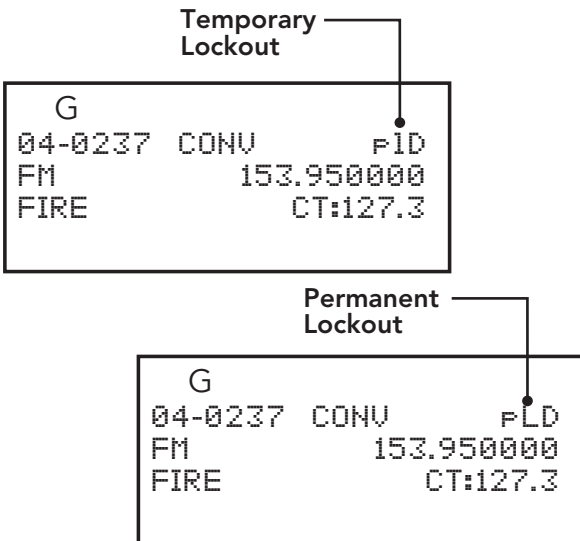

OBJECT LOCKOUT

To remove a lockout:

1. Navigate to the object using the 4-direction keypad.
2. Press **L/OUT**.
3. To remove a permanent lockout, press **FUNC** and then **L/OUT**.

To find objects that are locked out:

1. Press **PROG**.
2. Press the **EDIT** softkey.
3. Press the **FIND** softkey.
4. Press the **L/Out** softkey.
5. Press the **NEXT** softkey to find the next locked out object.

To edit the Search Lockout List:

1. Press **PROG**
2. Press the **GLOB** softkey
3. Scroll down to **SRCH L/Outs** and press **SEL**.
4. To manually add to the list, scroll to an empty spot and enter the frequency.
5. To remove a frequency, press the **Del** softkey.
6. To clear the entire list, press **FUNC** and then the **Del** softkey.

MULTI-SITE MODE

Multi-Site Mode (Motorola and P25)

Some Motorola and P25 system sites are networked to provide wider coverage, similar to a cellular network. Like in a phone network coverage area, their radios automatically use the nearest tower site.

To activate Multi-site mode:

1. Press **PROG**,
2. Use the 4-direction keypad to navigate to a talkgroup on the networked multi-site system.
3. Press the **EDIT** softkey.
4. Press the **CURR** softkey.
5. Scroll down to the **TSYS** item and press **SEL** to edit the system parameters.
6. Scroll to **Multi-Site**, and use the four-direction keypad to select:
 - **Off** – The scanner will use the first usable control channel in the control channel list.
 - **Stat** – The scanner will track the system using any usable control channel in the list.
 - **Roam** – The scanner will use only the best control channel. You can adjust the Threshold values to improve performance.
7. Press the **SAVE** softkey.
8. Press the **SAVE** softkey again.

NOTE: You should experiment with the different multi-site modes and the threshold settings to find a combination that works best for your location.

HOME REPEATER

Home Repeater AutoMove (LTR)

LTR Home Repeater AutoMove lets you program LTR trunking systems, even if you don't know the home repeater. When active, you may enter the LTR system frequencies in any order, and AutoMove automatically moves the frequencies to home repeater slots as transmissions are received.

To enable LTR Home Repeater Automove:

1. Press **PROG**,
2. Use the 4-direction keypad to navigate to the **LTR TSYS** object.
3. Scroll down to the last item in the menu, **AutoMove HRs**.
4. Use the four-direction keypad to toggle **AutoMove HRs** on or off
5. Press the **Save** softkey.

SEARCHING

Searching

Your scanner lets you search for frequencies in your area. When you find a frequency, you can save them as objects:

- Tune Search – Tune a frequency and begin an immediate search.
- Limit Search – Search within a defined range.
- Service Search – Optimized for radio services
- Spectrum Sweeper – Rapidly sweeps a frequency range for nearby strong signals.

To start a tune search:

1. Press **TUNE**. The most recent **TUNE** frequency appears.

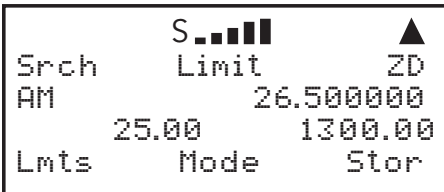

2. Press **PAUSE**. The scanner begins the search.

To start a limit search:

1. Press the **SRCH** key repeatedly until the display indicates **Srch Limit**.
When a signal is received, the **Lmts** softkey changes to **FrLO**. You can access the **Lmts** softkey by pressing **FUNC**.
2. To change the lower and upper frequency limits, press the **Lmts** softkey.

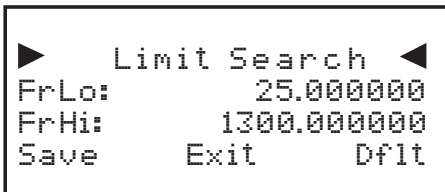

3. Edit the frequencies and press the **Save** softkey.

SEARCHING

To start a service search:

Press the **SRCH** key repeatedly until the display indicates: Railroad, Public Safety, Aircraft, Ham, CB, Marine, or FRS/GMRS/MURS/DOT.

```
S.■■■■
Srch  Pubsaftey  ZD
FM      154.310000
Pub Safety:    01234
FrL/O          Stor
```

To start a Spectrum Sweeper search:

1. Press **FUNC** and then **SCAN**.
2. To toggle between All band or Public Safety bands, press the **Bands** softkey.

```
S.■■■■
Sweeper          ZID
FM      154.310000
All:      0.2..5.78.
Band      spcl    Stor
```

Found Frequencies

- Use the 4-direction keypad to change search direction.
- Use the number keys to enable/disable sub-bands.
- Press the **MODE** softkey to change the receive mode (AM, FM, NFM).
- Press the **FrL/O** softkey lock out a frequency.
- Press the **STOR** softkey to create a new CONV object using the found frequency.

TIP: Found signals can be saved or locked out; both functions can be useful.

LIMIT SEARCH

Limit Search Object (LMIT)

Because a LMIT object is assigned to a scan list, it can be used to search while the radio is scanning. It can also be used as a stand-alone search.

To create a new LMIT object:

1. Press **PROG**.
2. Press the **NEW** softkey.

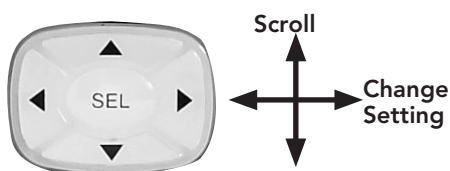

3. Press the **SRCH** softkey.
4. Press the **LMIT** softkey.
5. Configure settings for the object. To restore the default setting, press the **Dflt** softkey. Enter the beginning (FrLo) frequency then enter the ending (FrHi) frequency.
6. Name your search in the **Tag** field.
7. To search while scanning, assign the object to a scan list.
8. Press the **Save** softkey.

To begin a Limit search:

1. Press **MAN**.
2. Use the 4-direction keypad to navigate to the LMIT object.
3. Press the **SRCH** softkey (not **SRCH** on the keypad).
4. Press **PAUSE** to hold on a transmission. To resume, press **PAUSE** again.
 - Press the **FrL/O** softkey lock out a frequency.
 - Press the **STOR** softkey to create a new CONV object using the found frequency.

LIMIT SEARCH

LMIT Menu Reference

Scan Lists – Press **SEL** to assign the object to scan lists. An asterisk (*) indicates an assigned scan list.

FrLo – Lowest frequency in the range.

FrHi – Highest frequency in the range.

Tag – The display name for the object.

L/Out – Permanent lockout status for the object.

LED Mode – Solid or Flash.

LED Color – 0=Off, 1=Red, 2=Yellow, 3=Green, 4=Cyan, 5=Blue, 6=Magenta, 7=White.

Latch LED – Off, the Alert LED is on only during a transmission; On, the Alert LED remains lit after a transmission, unless overridden.

Backlight – On, Off, or Flash.

Alarm – None, Chirp, Hi-Lo, Alert, Ring, 2-Chirp, Fast Hi-Lo, DTMF#.

Fav – Assigns the object to the Favorites scan list.

Modulation – Automatic, AM, FM, or NFM

Atten – Attenuation. On or Off.

Delay – On or off.

Delay Time – (1-250) Delay time in 100 ms.

Zeromatic – On or off.

Search Dir – Up or Down.

Hit Count – Number of received transmissions for the object. Global Hit Counts must be set to on. Press the **Dflt** softkey to reset to 0.

SERVICE SEARCH

Service Search Object (SRVC)

A Service Search Object (SRVC) is optimized for specific radio services across multiple frequency bands.

Because a SRVC object is assigned to a scan list, it can be used to search while the radio is scanning. It can also be used as a stand-alone search.

To create a new SRVC object:

1. Press **PROG**.
2. Press the **NEW** softkey.

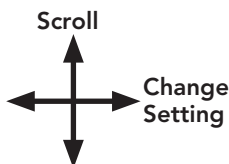

3. Press the **SRCH** softkey.
4. Press the **SRVC** softkey.
5. Configure settings for the object. To restore the default setting, press the **Dflt** softkey.
6. Name your search in the **Tag** field.
7. To search while scanning, assign the object to a scan list.
8. Press the **Save** softkey.

To begin a Service search:

1. Press **MAN**.
2. Use the 4-direction keypad to navigate to the SRVC object.
3. Press the **SRCH** softkey (not the **SRCH** key on the keypad).
4. Press **PAUSE** to hold on a transmission. To resume, press **PAUSE** again.
 - Press the **FrL/O** softkey lock out a frequency.
 - Press the **STOR** softkey to create a new CONV object using the found frequency.

SERVICE SEARCH

SRVC Menu Reference

Scan Lists – Press **SEL** to assign the object to scan lists. An asterisk (*) indicates an assigned scan list.

SRVC – Service Radio Services: Public Safety, Aircraft, Amateur, CB, Marine, FRS/GMRS/MURS/DOT/STAR and Railroad

For Frequency information, see Specifications.

Groups – Toggle search groups when Pub Safety, Aircraft and Amateur service searches are used.

Tag – The display name for the object.

L/Out – Permanent lockout status for the object.

LED Mode – Solid or Flash.

LED Color – 0=Off, 1=Red, 2=Yellow, 3=Green, 4=Cyan, 5=Blue, 6=Magenta, 7=White.

Latch LED – Off, the Alert LED is on only during a transmission; On, the Alert LED remains lit after a transmission, unless overridden.

Backlight – On, Off, or Flash.

Alarm – None, Chirp, Hi-Lo, Alert, Ring, 2-Chirp, Fast Hi-Lo, DTMF#.

Fav – Assigns the object to the Favorites scan list.

Modulation – Automatic, AM, FM, or NFM

Atten – Attenuation. On or Off.

Delay – On or off.

Delay Time – (1-250) Delay time in 100 ms.

Zeromatic – On or off.

Search Dir – Up or Down.

Hit Count – Number of received transmissions for the object. Global Hit Counts must be set to on. Press the **Dflt** softkey to reset to 0.

SPECTRUM SWEEPER

Spectrum Sweeper Object (SWPR)

Spectrum Sweeper can find distant or weaker signals.

With default settings, the SWPR object will sweep through important land mobile radio bands. As you become more familiar with SWPR operation, you can specify bands to improve your search.

Because a SWPR object is assigned to a scan list, it can be used to search while the radio is scanning. It can also be used as a stand-alone search.

To create a new SWPR object:

1. Press **PROG**.
2. Press the **NEW** softkey.

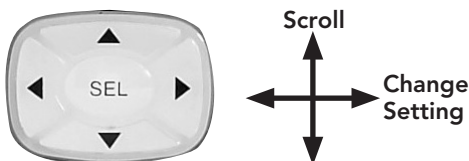

3. Press the **SRCH** softkey.
4. Press the **SWPR** softkey.
5. Configure settings for the object. To restore the default setting, press the **Dflt** softkey.
6. Name your search in the **Tag** field.
7. To search while scanning, assign the object to a scan list.
8. Press the **Save** softkey.

To begin a Spectrum Sweeper search:

1. Press **MAN**.
2. Use the 4-direction keypad to navigate to the SWPR object.
3. Press the **SWPR** softkey (not the **SRCH** key on the keypad).
4. Press the **PAUSE** key to hold on a transmission. To resume, press the **PAUSE** key again.
 - Press the **FrL/O** softkey lock out a frequency.
 - Press the **STOR** softkey to create a new CONV object using the found frequency.

SPECTRUM SWEEPER

SWPR Menu Reference

Scan Lists – Press **SEL** to assign the object to scan lists. An asterisk (*) indicates an assigned scan list.

Type – All Bands or Public Safety. Public Safety activates Sub-bands.

Sub-bands – Press Sel to toggle active Public Safety sub-bands. An asterisk (*) indicates an active sub-band.

Tag – The display name for the object.

L/Out – Permanent lockout status for the object.

LED Mode – Solid or Flash.

LED Color – 0=Off, 1=Red, 2=Yellow, 3=Green, 4=Cyan, 5=Blue, 6=Magenta, 7=White.

Latch LED – Off, the Alert LED is on only during a transmission; On, the Alert LED remains lit after a transmission, unless overridden.

Backlight – On, Off, or Flash.

Alarm – None, Chirp, Hi-Lo, Alert, Ring, 2-Chirp, Fast Hi-Lo, DTMF#.

Fav – Assigns the object to the Favorites scan list.

Atten – Attenuation. On or Off.

Delay – On or Off.

Delay Time – (1-250) Delay time in 100 ms.

Zeromatic – On or off.

Special – On or Off. Sweeps the RF spectrum in 1 MHz increments. If the sweep finds activity SWPR sweeps that range to find the source.

Search Dir – Up or Down.

Hit Count – Number of received transmissions for the object. Global Hit Counts must be set to on. Press the **Dflt** softkey to reset to 0.

Weather Features

While scanning, your radio will check your Weather Priority channel periodically for the All Hazards Warning Alert Tone (WAT). If the WAT is received, your scanner tunes to the Weather Priority channel, sounds an alert, and flashes the LED (RED=warnings, YELLOW=watches, and BLUE=tests and administrative messages) until the 1050 Hz WAT begins, followed by the voice portion of the alert.

NOTE: The included antenna is optimized for general purpose scanning. Verify your signal strength or connect an external antenna.

To use weather radio mode:

1. Press **WX**. The scanner quickly locates an active weather radio frequency.
2. You can use the 4-direction keypad to search for other weather radio transmitters.
3. To activate Weather Priority Mode, locate the strongest weather radio transmitter in your area and press **PRI**.

SAME Standby

The National Weather Service precedes all weather alerts with a digitally encoded Specific Area Message Encoding (SAME) signal that designates specific alert areas. To define your alert area, you can program the SAME code for your area.

NOTE: If no SAME location codes are saved, your radio will alert on all messages received.

A list of SAME location codes can be found online at: www.nws.noaa.gov

A list of event codes can be found online at: www.weather.gov/os/eas_codes.shtml

SAME STANDBY

SAME codes can include numbers and letters. The standard text entry is used to enter both numerical and extended SAME codes.

NOTE: The text entry method for numbers requires that you precede each number with **1**. For example, to enter 4, press **1** and then **4**. To enter SAME code 048113, press **10, 14, 18, 11, 11, 13**.

To create a SAME entry:

1. Press **WX**.
2. Press the **SAME** softkey.
3. Scroll to the desired **SAME** code entry.
4. Press **SEL**.
5. Configure settings for the SAME entry. To restore default setting, press the **Dflt** softkey.
6. Press the **Save** softkey to store the data.
7. Press the **Save** softkey again to save all SAME changes and return to the Weather mode.

SAME Wildcards

Your scanner supports SAME wildcards for partial matches of location codes. For example, the SAME location code for Dallas, TX is 048113:

SAME Code Menu Reference

Entry – On or Off.

Code – Enter the code. See Code entry.

Event – Event code. Targets specific events. The default alert code (***) is best for most general purpose weather alert monitoring purposes.

Tag – The display name for the SAME code.

Alarm – None, Default, Siren 1-4.

Lockout – Off or On. Use with caution.

SAME STANDBY

County Subdivision	State Code (Texas)	County Code
0	48	113

You can program a wildcard for any SAME code that matches 48 for the state of Texas:

*48***

To activate SAME standby mode:

1. Press **WX**. The scanner quickly locates an active weather radio frequency.
2. When the scanner stops on a frequency, press the **stby** softkey. The softkey will change to **STBY**, and the scanner will alert when a matching SAME message is received.
3. To exit SAME Standby Mode, press the **STBY** softkey again, or press **MAN**, **SCAN** or **PROG**.

Your scanner will resume SAME Standby operation 90 seconds after the SAME warning starts. You may reset standby mode by pressing the STBY softkey twice at any time.

Configuring

Your WS1065 scanner includes Global Settings that store radio-wide settings.

Caution: The Special Global Settings menu (**PROG** + **GLOB**) includes parameter settings that, if not set properly, may adversely affect the performance of your radio. We recommend caution when changing these settings.

NOTE: Each parameter includes a **Dflt** softkey that restores the factory default setting.

Context sensitive help is available for all parameters. Press **FUNC** and then **SEL** to view help. Press **SEL** again to exit help.

GLOB Menu Reference

Contrast – Sets LCD contrast.

Owner – Sets Welcome Message text display.

Clone Send – Press **SEL** to send data to clone.

Alert Mode – Tone, Light, Both, or Off.

Sound Mode – On or Stlth (Silent).

Key Beeps – On or Off.

Light Mode – Norml, Delete Key, Ignre, On, or Stlth.

Light Level – Dim, Brit, or Off.

Dim LED – Yes or No.

Atten Mode – Attenuator reduces interference from nearby transmitters. **Global** applies attenuation to all objects. **Normal** uses object attenuator settings.

Global Atten – On or off.

Clear Hits – Press **SEL** to clear all hit counters.

Hit Counts – Toggles the hit counter feature.

Dflt ScanList – Sets the default scan list for new objects (0-22).

GLOBAL MENU

GLOB Menu Reference (Cont.)

Priority – On or Off.

WxPri – Off or select one of the 7 WX channels.

Scan Lists – Enters the scan list sub menu.

SRCH L/Outs – Enters the search lockout frequencies sub menu.

Clear FAV – Clears the Favorites Scan List.

Memory Info – Displays memory usage.

Tune LED – Activates signal strength driven LED in Tune mode.

Color 0-7 – LED colors. Use number keys for preset intensity levels. Use the four-way keypad for RGB LED settings for each LED and to adjust intensity.

Qtxt 1-0 – Sets QuickText (1-10).

Key Repeat – Key repeats when held down. On or Off.

LCD BlinkOff – For alternating text displays, sets the display time for the secondary display element (1-250 x 10 mS).

LCD BlinkOn – Sets the display time for the primary display element (1-250 x 10 mS).

LED BlinkOff – When Alert LED is set to Flash, the LED OFF duration (1-250 x 10 mS).

LED BlinkOn – When Alert LED is set to Flash, the LED ON duration (1-250 x 10 mS).

Pri Channels – Number of priority CONV channels to check during a priority scan sampling (0-250, 0=All CONV priority channels).

Pri Interval – Priority sample interval (2-100 x 100 mS).

TGRP Pri Int – Priority interrupt during trunked calls (On or Off).

GLOBAL MENU

GLOB Menu Reference (Cont.)

QuickPriRtn – On or Off. When On, does not wait for verification of CTCSS, DCS or NAC when returning to an active CONV channel after priority sampling

Search Delay – Delay for all search modes (1-250 x 100 mS).

SRCH Dig AGC – On or Off. Digital AGC for all search types compensates for low or high digital audio levels caused at the system.

SRCH SuprTrk – On or Off. Alternative DSP decoding algorithm is applied to all search types.

TLO=FUNC L/O – When No, **L/OUT** = Temporary Lockout; when Yes, **L/OUT** = Permanent Lockout.

DupeChecksSQ – Yes or No. Checks both frequency and encoded squelch settings when checking for duplicate CONV objects.

TGID Format – Norm, DEC, or HEX.

TGRP Ignore – Yes or No. Ignore calls on TGRPS that are mapped to disabled Scan Lists.

ShowCCInfo – Yes or No. For Motorola and P25 systems, the display alternates the voice frequency and current control channel index (from TSYS frequency list) and frequency.

Set Password – Set Power-on password.
0000=none.

Using V-Scanner Storage

Your WS1065 features two types of memory storage: Main memory, which stores programming for monitoring and scanning, and Virtual Scanner (V-Scanner) memory.

V-Scanner folders (21) are each capable of storing complete copies of your scanner's main memory (including objects, global settings, and dedicated search configurations). This is like having 21 scanners in one. You can customize multiple main memory configurations, each for different situations.

NOTE: If you load a V-scanner into main memory, the current contents of main memory are overwritten and cannot be recovered; there is no "Undo."

To save the current contents of your scanner's main memory to a V-Scanner folder:

1. Press **FUNC** and then **PROG**.
2. Press the **Stor** softkey.
3. Use the 4-direction keypad to select a V-Scanner folder.
4. Press the **Stor** softkey. If the selected V-Scanner folder already contains data, you will be asked if you wish to overwrite the existing data with new data.
5. The scanner may prompt you for a name for the V-Scanner. (The current name or Line 4 of the Welcome Screen appears. If you change the name here, it will not overwrite the Welcome Screen text.)

V-SCANNER STORAGE

To load a saved V-Scanner folder into main memory:

1. Press **FUNC** and then **PROG**.
2. Press the **Load** softkey.
3. Use the 4-direction keypad to select a V-Scanner folder.
4. Press the **Load** softkey. The scanner will ask you to confirm that you wish to overwrite the current contents of main memory.

NOTE: If you recall a configuration from a V-Scanner storage folder and use it in main memory, any changes you make while using the configuration will not automatically be transferred to the configuration data stored in the V-Scanner storage folder. You must save your changes back to that folder location if you want to preserve them for later use.

To erase a V-Scanner folder:

1. Press **FUNC** and then **PROG**
2. Press the **Eras** softkey.
3. Use the 4-direction keypad to select a V-Scanner folder.
4. Press the **Eras** softkey. The scanner will ask you to confirm that you wish to erase the selected V-Scanner folder.

INITIALIZING GLOBAL SETTINGS

Initializing Global Settings

You can reset the global radio parameters to their factory state without losing information stored in the scanner's working memory. However, any changes to the radio's global settings will be lost.

NOTE: V-Scanner memory is not affected by this operation.

To initialize Global settings:

1. Turn off the scanner, then turn it on again.
2. When the Welcome/Ownerscreen appears, press **0**. The scanner displays:

```
System Tests:  
Select a Test...  
Exits if no key  
is pressed
```

3. Press **2**. The scanner displays:

```
Init GLOB data  
To factory state  
ENTER if APPROVE  
CLEAR to EXIT
```

4. Press **ENT**. The scanner displays:

```
GLOB EEPROM area  
Initialized to defaults.  
Press any key.
```

5. Press any key to proceed. The scanner reboots with default global parameters.

INITIALIZING FACTORY DEFAULTS

Initializing to Factory Defaults

You can initialize the entire scanner to factory defaults. This clears all programmed data and global settings.

NOTE: You can save your working memory to a V-Scanner folder before performing this operation. V-Scanner memory is not affected by this procedure.

To initialize to factory defaults:

1. Turn off the scanner, then turn it on again.
2. When the Welcome/Ownerscreen appears, press **0**. The scanner displays:

```
System Tests:  
Select a Test...  
Exits if no key  
is pressed
```

3. Press **1**. The scanner displays:

```
Factory Init  
Erase Memory  
ENTER if APPROVE  
CLEAR to EXIT
```

4. Press **ENT**. The scanner displays:

```
File System  
Initialized to Defaults.  
Press any key.
```

5. Press any key to proceed. The scanner reboots with file system and global parameters reset to factory defaults.

CONFIGURATION SHORTCUTS

Configuration Shortcuts

Your WS1065 features power-on shortcuts to configuration items, such as attenuator settings, backlight settings and memory information.

The following table lists the power-on key sequences available in the WS1065.

Unless otherwise specified, press each sequence while the scanner displays the Welcome/Owner screen.

Sequence	Function
1	Shortcut to Sound Mode
2	Shortcut to Key Beeps
3	Displays Boot, CPU, and DSP versions
DIM	Shortcut to Light Mode
ATT	Shortcut to Attenuator Mode
0, 0	Shortcut to Memory Information
0, 1	Destructive, clears working memory and resets all global parameters to factory defaults. Does not affect V-Scanners.
0, 2	Destructive, resets all global parameters to factory defaults. Does not affect working memory or V-Scanners.
0, 5	Destructive, executes EEPROM memory test, then clears working memory and resets all global parameters to factory defaults.
0, CLR	Erases DSP APP Upgrade code, restores factory DSP version.
0, PROG	Places scanner in DSP APP firmware upgrade mode.
Hold PROG and turn unit on	Places scanner in CPU firmware upgrade mode.

MANUAL PROGRAMMING GUIDE

The simplest method for programming your scanner is to use the included PC/IF Cable. However, there also may be times that you need to program objects into your scanner manually. This Manual Programming Guide is primarily intended to supplement your programming experience.

TIP: Remember that there is context sensitive help available for each menu item when you program your scanner. To access the help, press **FUNC** and then **SEL**. Press **SEL** again to exit the help screen.

CONVENTIONAL OBJECTS

Conventional Objects (CONV)

A Conventional Channel Object (CONV) is a single conventional frequency.

To create a new CONV object:

1. Press **PROG**.
2. Press the **NEW** softkey.
3. Press the **CONV** softkey.

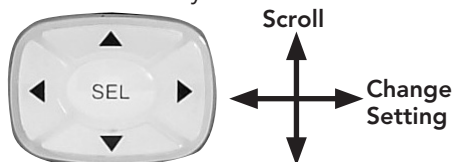

4. Configure settings for the object. To restore the default setting, press the **Dflt** softkey.
5. To scan the object, you must assign the object to at least one scan list.
6. Press the **Save** softkey.

CONV Menu

Scan Lists – Press **SEL** to assign the object to scan lists. An asterisk (*) indicates an assigned scan list.

Freq – Enter frequency in MHz.

Tag – The display name for the object.

Sq Mode – Subaudible squelch mode or Project 25 conventional digital modulation.

Search	Automatically analyzes signals to determine squelch mode and code
None	Ignore subaudible squelch
CTCSS	Tone coded squelch. Squelch Code required.
DCS	Digitally coded squelch. Squelch Code required.
P25	Project 25. Squelch Code required.

Squelch Code – Use Search to detect tone or code value for selected squelch type.

CONVENTIONAL OBJECTS

CONV Menu (Cont.)

L/Out – Permanent lockout status for the object.

Priority – On or off.

LED Mode – Solid or Flash.

LED Color – 0=Off, 1=Red, 2=Yellow, 3=Green, 4=Cyan, 5=Blue, 6=Magenta, 7=White.

Latch LED – Off, the Alert LED is on only during a transmission; On, the Alert LED remains lit after a transmission, unless overridden.

Backlight – On, Off, or Flash.

Alarm – None, Chirp, Hi-Lo, Alert, Ring, 2-Chirp, Fast Hi-Lo, DTMF#.

Fav – Assigns the object to the Favorites scan list.

Skywarn – Assigns the object to the Skywarn Scan List.

Modulation – Automatic, AM, FM, or NFM

Atten – Attenuator, applies 20 dB of attenuation to reduce interference from strong signals.

Delay – On or off.

Delay Time – (1-250) Delay time in 100 ms.

Digital AGC – On or off.

Supertrack – Alternative DSP decoding algorithm. May help reception on some systems.

AudioBoost – 6 dB audio level boost.

Hit Count – Number of received transmissions for the object. Global Hit Counts must be set to on. Press the **Dflt** softkey to reset to 0.

TRUNKING SYSTEM OBJECT

Trunking System Object (TSYS)

You must create a TSYS object that contains the system parameters for each trunked radio system.

To create a new TSYS object:

1. Press **PROG**.
2. Press the **NEW** softkey.
3. Press the **TGRP** softkey.

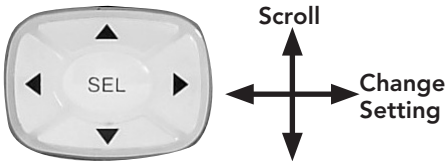

4. Scroll to the TSYS parameter and press **SEL**.
5. Configure settings for the object. To restore the default setting, press the **Dflt** softkey.
6. Press the **Save** softkey.

TSYS Menu

Type – Defines the system type:

MOT 800/900	Motorola 800 or 900 MHz analog or digital , 3600 baud control channel
MOT VHF/UHF	
P25 MANUAL	Use default 800 MHz table data.
P25 AUTO	Project 25, table data via control channel
EDACS STD	800 MHz EDACS, 9600 BPS EDACS control channel.
EDACS NAROW	900 MHz and some VHF/UHF EDACS, 4800 BPS EDACS control channel
LTR	Logic Trunked Radio

Tag – The display name for the object.

Frequency – Control channel frequencies:

Motorola and P25	Any order
EDACS	LCN order
LTR	Home Repeater order.

TRUNKING SYSTEM OBJECT

TSYS Menu (Cont.)

L/Out – Permanent lockout status for the object.

Atten – Attenuator, applies 20 dB of attenuation. Useful in areas with interference from strong signals.

Narrow FM – Used by most 900 MHz analog systems. Not used by digital systems.

AudioBoost – 6 dB audio level boost.

Dwell – (0-200 x 100 mS) The time in milliseconds that the scanner dwells on a Motorola, P25, or EDACS system control channel. Automatic=0, which uses control channel information.

Digital AGC – Controls Digital AGC function.

Supertrack – Alternative DSP decoding algorithm.

Multi-Site – Used with networked Motorola and P25 trunked radio systems.

OFF	Uses the first usable control channel in the control channel list.
STAT	Uses every usable control channel in the control channel list.
ROAM	Uses the control channel with the best decoding quality, lower than Threshold Hi. Searches for a new control channel when the current control channel drops below Threshold Lo.
Threshold Hi (1-99)	Upper control channel threshold percentage
Threshold Lo (1-99)	Lower control channel threshold percentage

T Tables – (Default, Splinter, Custom) For Motorola and P25 systems only.

Fleet Map – For Motorola Type I systems only.

TALKGROUP OBJECT

Talkgroup Object (TGRP)

A Talkgroup Object (TGRP) stores the parameters for a talkgroup on a trunked radio system.

To create a new TSYS object:

1. Press **PROG**.
2. Press the **NEW** softkey.
3. Press the **TGRP** softkey.

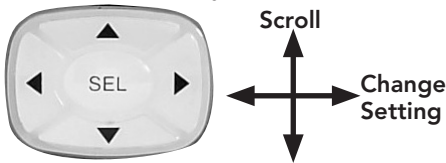

4. Configure settings for the object. To restore the default setting, press the **Dflt** softkey.
5. To scan the object, you must assign the object to at least one scan list.
6. Press the **Save** softkey.

By default, the talkgroup ID is set to Wildcard. You may wish to save your TGRP object as a Wildcard with no further changes.

Wildcard monitors all talkgroup call traffic on the associated system, which can help you quickly find and store new talkgroups. When a Wildcard TGRP object is scanned, all talkgroup traffic on the system is scanned.

TIP: Wildcard objects are easier to manage if you name the system in the **Tag** field.

TALKGROUP OBJECT

TGRP Menu

Scan Lists – Press **SEL** to assign the object to scan lists. An asterisk (*) indicates an assigned scan list.

TSYS – Select or define a TSYS object.

ID – Digital address for the talkgroup or individual radio (Wildcard, Decimal, hex or AFS, depending on TSYS type) Wildcard monitors all talkgroup call traffic on the associated system

Type – **Group** = Talkgroup ID;
Private = individual radio ID.

Tag – The display name for the object.

L/Out – Permanent lockout status for the object.

Priority – On or off.

LED Mode – Solid or Flash.

LED Color – 0=Off, 1=Red, 2=Yellow, 3=Green, 4=Cyan, 5=Blue, 6=Magenta, 7=White.

Latch LED – Off, the Alert LED is active only while the object is receiving a transmission; On, the Alert LED will remain lit after the transmission is complete, unless overridden.

Backlight – On, Off, or Flash.

Alarm – None, Chirp, Hi-Lo, Alert, Ring, 2-Chirp, Fast Hi-Lo, DTMF#.

Fav – Assigns the object to the Favorites scan list.

Skywarn – Assigns the object to the Skywarn Scan List.

Delay – On or off.

Delay Time – (1-250) Delay time in 100 ms.

AudioBoost – 6 dB audio level boost.

Hit Count – Number of received transmissions for the object. Global Hit Counts must be set to on. Press the **Dflt** softkey to reset to 0.

DUPLICATING OBJECT

Duplicating Objects

Duplicating objects lets you define multiple objects with similar characteristics, especially TGRP objects that are hosted on the same trunked system.

TIP: Duplicate your wildcard TGRP object and then set the Type to Private, so you'll have a TGRP wildcard for talkgroup calls and another for private calls.

To duplicate an object:

1. Press **PROG**.
2. Select an object.
3. Press the **EDIT** softkey.
4. Press the **DUPE** softkey. This creates an exact copy of the selected object.
5. Change the tag name and any other object parameters before saving your new object.
6. Press the **SAVE** softkey.

No Scan List

If you store an object with no scan list mappings, the object will be placed in the NS Scan List.

1. Locate the **NS** list, and use the 4-direction keypad to access the list.
2. Select an object and press **PROG**.
3. Press the **EDIT** softkey.
4. Press the **CURR** softkey.
5. Use the four-direction keypad to assign the object to a scan list.

DELETING OBJECT

Deleting Objects

To delete an object:

1. Press **PROG**.
2. Select an object.
3. Press **FUNC** and **CLR** to delete the object.
4. Confirm the delete command. Deletions cannot be undone.

CAUTION: If you delete a TSYS object, all TGRP objects associated with that TSYS will require a new TSYS to function.

Memory Usage

Your scanner can report used memory, available memory, and memory allocation.

To display the memory usage report:

Turn on the scanner. While the Welcome message appears, press 0 and then press 0 again.

OR

1. Press **PROG**.
2. Press the **GLOB** softkey to access the Global configuration menu
3. Scroll down to **Memory Info**.
4. Press **SEL** to view the memory usage report.

HIT COUNTER

Hit Counter

The Hit Counter feature keeps track of how many transmissions are received for each object type. By default, the hit counter is turned off.

To turn the Hit Counter on:

1. Press **PROG**.
2. Press the **GLOB** softkey.
3. Scroll to **Hit Counts**.
4. Use the 4-direction keypad to turn on **Hit Counts**.
5. Press the **SAVE** softkey.

To view the hit counts for an object:

1. Navigate to the object.
2. Press **PROG**.
3. Press the **EDIT** softkey.
4. Press the **CURR** softkey.
5. Scroll to **Hit Count**.
6. To reset the hit counter for a single object, press the **Dflt** softkey.

To clear all hit counters:

1. Press **PROG**.
2. Press the **GLOB** softkey.
3. Scroll down to the **Clear Hits** item.
4. Press the **SEL** key.
5. Press the **SAVE** softkey to save your changes and exit the Global settings menu.

SPECIFICATIONS

Specifications

Working Memory

1800 programmed objects (conventional channels, trunking talkgroups, limit searches, service searches, and Spectrum Sweeper configurations) using flexible "Scannable Object" system.

Virtual Scanners

21 Virtual Scanner (V-Scanner) folders.

Searches

Seven preprogrammed dedicated service searches, one dedicated limit search. Programmable service or limit search objects.

Priority

Talkgroup and conventional channel priority.

Conventional Receiver Modes

AM, FM, NFM, CTCSS, DCS, P25 NAC

Trunking Receiver Modes

Motorola Type I/II/III Analog and Digital, GE/Ericsson/MA-COM EDACS Narrowband and Wideband, EF Johnson LTR

Receiver System

Triple conversion PLL super-heterodyne

1st IF 380.8 MHz

(The 1st LO uses high side of receive frequency range for VHF and UHF Low/T, and low side of receive frequency range for >512 MHz)

2nd IF 21.4 MHz

The second LO uses low side of 1st IF)

3rd IF 455 kHz

(The 3rd LO uses the low side of the 2nd IF)

Frequency Range

VHF Low..... 25.00000 - 54.00000 MHz

VHF Aircraft..... 108.00000 - 136.99166 MHz

VHF High..... 137.00000 - 174.00000 MHz

..... 216.00250 - 224.9950 MHz

..... 225.00000 - 299.93750 MHz

UHF Low/T 300.00000 - 512.00000 MHz

UHF High 764.00000 - 960.00000 MHz*

..... 1240.00000 - 1300.00000 MHz

*Excludes Cellular Mobile Radiotelephone Service frequencies

SPECIFICATIONS

Spectrum Sweeper Band Groups

All Bands:

0: 25-54 MHz	VHF Low Band
1: 108-137 MHz	VHF Aircraft Band
2: 137-174 MHz	VHF High Band
3: 216-300 MHz	220 MHz Commercial/Amateur Band
4: 300-406 MHz	UHF Military Air Band
5: 406-470 MHz	UHF Band
6: 470-512 MHz	UHF-T Band
7: 764-797 MHz	700 MHz Band
8: 806-869 MHz	800 MHz Band
9: 894-1300 MHz	900 MHz Band, 23 cm Amateur Band

Preprogrammed Service Searches

Public Safety

0: 30.8-47.6 MHz	VHF Low Band
1: 151-173 MHz	VHF High Band
2: 453-468 MHz	UHF Band
3: 764-797 MHz	700 MHz Band
4: 851-869 MHz	800 MHz Band

Aircraft

0: 108-118 MHz	Navigation
1: 118-137 MHz	Civilian Voice
2: 138-150 MHz	Military Voice (excludes 2m Amateur)
3: 225-400 MHz	Military Voice

Ham

0: 28.0-29.7 MHz	10m Band
1: 50-54 MHz	6m Band
2: 144-148 MHz	2m Band
3: 222-225 MHz	1.25cm Band
4: 420-450 MHz	70cm Band
5: 902-928 MHz	33cm Band
6: 1240-1300 MHz	23cm Band

SPECIFICATIONS

CB – Searches the Citizens Band radio frequencies.
Marine – Searches the VHF-FM marine radio band.
FRS/GMRS/MURS/DOT/STAR (F/G/MURS)
Railroad – Searches the Association of American
Railroads (AAR) VHF railroad frequencies used in the
US and Canada.

Weather frequencies ... 162.400, 162.425, 162.450, 162.475,
162.500, 162.525, 162.550 MHz

Scanning Rate Approx. 40-60 channels per second

Search Rate Approx. 60-90 steps per second

Display LCD with amber LED backlight, 4 lines of 16
characters each, plus 13 display icons

Zeromatic Automatically zeroes receiver on correct
frequency during searches

Audio Output 1.8 W

Internal Speaker 77 mm 8 ohms dynamic

Operating Voltage 12-14.4 VDC, 13.8 VDC nominal,
16VDC Max.

Dimensions (WxDxH) 7.3 x 5.3 x 2.2 inches
185 x 135 x 55 mm

Weight Approx. 42.3 ounces, 1200 grams
(not including mounting hardware and antenna)

Memory backup No backup battery required, utilizes
non-volatile EEPROM memory

Specifications are typical; individual units might vary.
Specifications and depictions are subject to change and
improvement without notice.

FREQUENCY COVERAGE

Frequency Coverage

25.000-26.960 MHz.....	(in 10 kHz steps/AM)
26.965-27.405 MHz.....	(in 10 kHz steps/AM)
27.410-29.505 MHz.....	(in 5 kHz steps/AM)
29.510-29.700 MHz.....	(in 5 kHz steps/FM)
29.710-49.830 MHz.....	(in 10 kHz steps/FM)
49.835-54.000 MHz.....	(in 5 kHz steps/FM)
108.000-136.9916 MHz.....	(in 8.33 kHz steps/AM)
137.000-137.995 MHz.....	(in 5 kHz steps/FM)
138.000-143.9875 MHz.....	(in 12.5 kHz steps/FM)
144.000-147.995 MHz.....	(in 5 kHz steps/FM)
148.000-150.7875 MHz.....	(in 12.5 kHz steps/FM)
150.800-150.845 MHz.....	(in 5 kHz steps/FM)
150.8525-154.4975 MHz.....	(in 7.5 kHz steps/FM)
154.515-154.640 MHz.....	(in 5 kHz steps/FM)
154.650-156.0450 MHz.....	(in 7.5 kHz steps/FM)
156.0500 MHz.....	(FM)
156.0525-156.1725 MHz.....	(in 7.5 kHz steps/FM)
156.1750 MHz.....	(FM)
156.1800-156.2475 MHz.....	(in 7.5 kHz steps/FM)
156.2500-156.2550 MHz.....	(in 5 kHz steps/FM)
156.275-157.450 MHz.....	(in 25 kHz steps/FM)
157.470-160.8225 MHz.....	(in 7.5 kHz steps/FM)
160.8250 MHz.....	(FM)
160.830-161.5725 MHz.....	(in 7.5 kHz steps/FM)
161.600-161.975 MHz.....	(in 5 kHz steps/FM)
162.000-174.000 MHz.....	(in 12.5 kHz steps/FM)
216.0025-219.9975 MHz.....	(in 5 kHz steps/FM)
220.000-224.995 MHz.....	(in 5 kHz steps/FM)
225.000-379.99375 MHz.....	(in 6.25 kHz steps/AM)
380.000-419.9875 MHz.....	(in 12.5 kHz steps/FM)
420.000-450.000 MHz.....	(in 5 kHz steps/FM)
450.00625-512.000 MHz.....	(in 6.25 kHz steps/FM)
764.000-781.996875 MHz..	(in 3.125 kHz steps/FM)
791.000-796.996875 MHz..	(in 3.125 kHz steps/FM)
806.000-823.9875 MHz.....	(in 12.5 kHz steps/FM)
849.000-868.9875 MHz.....	(in 12.5 kHz steps/FM)
894.000-939.9875 MHz.....	(in 12.5 kHz steps/FM)
940.000-960.000 MHz.....	(in 6.25 kHz steps/FM)
1240.000-1300.000 MHz.....	(in 6.25 kHz steps/FM)

*Excludes frequencies utilized by the Cellular Mobile Radiotelephone Service: 824-848.9875 MHz and 869-893.9875 MHz

Maintenance

Keep the scanner dry; if it gets wet, wipe it dry immediately. Use and store the scanner only in normal temperature environments. Handle the scanner carefully; do not drop it. Keep the scanner away from dust and dirt, and wipe it with a damp cloth occasionally to keep it looking new.

Modifying or tampering with the scanner's internal components can cause a malfunction and might invalidate its warranty and void your FCC authorization to operate it.

Birdie Frequencies

Birdies are operating frequencies, which all scanners have, that are created inside the scanner's receiver and can cause interference. If the interference is not severe, adjusting the squelch might omit the birdie, but if you program one of these frequencies after a search you will hear only noise on that frequency.

To find birdies in your scanner:

1. Disconnecting the antenna.
2. Make sure that no other nearby radio or TV sets are turned on near the scanner.
3. Press **TUNE** and then press **PAUSE**. The scanner will search for frequencies and occasionally stop as if it has found a signal. This is a birdie.
4. Make a list of all the birdies in your scanner for future reference.
5. Press **L/OUT** to lock out the frequency for any future searches after you have reconnected the antenna.

PC INTERFACE

System Requirements

IBM PC or compatible computer equipped with Universal Serial Bus (USB) connection and Windows 8, Windows 7, Windows Vista and Windows XP

NOTE: Although the USB interface cable supports full speed USB communications, actual data transfer speed depends on the scanners hardware.

Installing USB drivers on Windows 8/7/Vista/XP

To install any new driver on Windows 8, Windows 7/ Vista/XP you need to log on as an administrator.

Insert the USB interface cable into the USB port your computer. Depending on the PC's Operating System the drivers for the interface cable maybe already installed. If so, the cable is now ready for use. Connect the scanner plug to the PC/IF port of your scanner.

If the drivers are not currently installed in the PC it will automatically launch the Found New Hardware Wizard. The PC will automatically start installing the USB cable drivers.

Viewing the Cable Port Settings

To specify the COM port number in your scanner application software, you can view the port settings when the cable is plugged into your computer.

1. Open your systems Control Panel. Double click the System icon.
2. Select the Hardware tab, then select Device Manager.
3. Scroll to Ports, then click the + sign to expand the Ports list.
4. Look in your PC's Device Manager for Ports (COM & LPT) to confirm the cables COM port number.

Installation Troubleshooting

- If Windows does not detect the cable when plugged in, try using any other USB port if available.
- If the installation fails, remove the cable and reboot your computer and perform the installation again.

FCC INFORMATION

FCC Statement

This equipment has been tested and found to comply with the limits for a scanning receiver, pursuant to Part 15 of the FCC Rules. These limits are designed to provide reasonable protection against harmful interference in a residential installation. This equipment generates, uses and can radiate radio frequency energy and, if not installed and used in accordance with the instructions, may cause harmful interference to radio communications. However, there is no guarantee that interference will not occur in a particular installation. If this equipment does cause harmful interference to radio or television reception, which can be determined by turning the equipment off and on, the user is encouraged to try to correct the interference by one or more of the following measures:

- Reorient or relocate the receiving antenna.
- Increase the separation between the equipment and receiver.
- Connect the equipment into an outlet on a circuit different from that to which the receiver is connected.

This device complies with Part 15 of the FCC Rules. Operation is subject to the following two conditions:

This device may not cause harmful interference.

This device must accept any interference received, including interference that may cause undesired operation.

WARRANTY

Consumer Warranty

This Whistler product is warranted to the original purchaser for a period of one (1) year from the date of original purchase against all defects in materials and workmanship, when purchased from an authorized Whistler retailer. **This limited warranty is void if the unit is abused, misused, modified, installed improperly, or if the housing and/or serial numbers have been removed.** There are no express warranties covering this product other than those set forth in this warranty. All express or implied warranties for this product are limited to one (1) year. *Whistler is not liable for damages arising from the use, misuse, or operation of this product including but not limited to loss of time, inconvenience, loss of use of your product or property damage caused by your product or its failure to work, or any other incidental or consequential damages including personal injury.*

DO NOT RETURN ITEM TO STORE WHERE PURCHASED.
**FOR WARRANTY INFORMATION, CONTACT WHISTLER
CUSTOMER SERVICE AT 1-866-923-8719.**

Representatives are available to answer your questions
Monday – Friday
from 8:00 a.m. to 5:00 p.m. CT

Service Under Warranty

During the warranty period, defective units will be repaired or replaced (with the same or a comparable model), at Whistler's option, without charge to the purchaser when returned prepaid, with dated proof of purchase to the address below. Units returned without dated proof of purchase will be considered out of warranty and therefore are not covered by the described Limited Warranty. (Refer to Service Out of Warranty section.)

Due to the specialized equipment necessary for testing Whistler products, there are no authorized service centers other than Whistler. When returning a unit for service under warranty, please follow these instructions:

WARRANTY

1. Ship the unit in the original carton or in a suitable sturdy equivalent, fully insured, with return receipt requested to:

Whistler Repair Dept.
1412 South 1st St.
Rogers, AR. 72756

Please allow 3 weeks turnaround time.

IMPORTANT: Whistler will not assume responsibility for loss or damage incurred in shipping. Therefore, please ship your unit insured with return receipt requested. **CODs will not be accepted!**

2. Include with your unit the following information, clearly printed:

- Your name and physical street address for shipping (no PO Boxes), a daytime telephone number, and an email address (if applicable).
- A detailed description of the problem (e.g., "device will not Power ON").
- A copy of your dated proof of purchase or bill of sale.

3. Be certain your unit is returned with its serial number.

Units without serial numbers are not covered under warranty.

IMPORTANT: To validate that your unit is within the warranty period, make sure you keep a copy of your dated proof of purchase. For warranty verification purposes, a copy of your dated store receipt must accompany any Whistler product sent in for warranty work.

WARRANTY

Service Out Of Warranty

Units will be repaired at "out of warranty" service rates when:

- The unit's original warranty has expired.
- A dated proof of purchase is not supplied.
- The unit has been returned without its serial number.
- The unit has been misused, abused, modified, installed improperly, or had its housing removed.

The minimum out of warranty service fee for your Whistler Scanner is \$120.00 (U.S.). If you require out of warranty service, please return your unit as outlined in the section "Service Under Warranty" along with a cashier's check or money order in the amount of \$120.00. Payment may also be made by MasterCard, VISA or American Express.

Personal checks are not accepted.

In the event repairs cannot be covered by the minimum service fee, you will be contacted by a Whistler technical service specialist who will outline options available to you.

IMPORTANT: When returning your unit for service, be certain to include a daytime telephone number and an email address (if applicable).

Customer Service

If you have questions concerning the operation of your Whistler product, or require service during or after the warranty period, please call Customer Service at **1-866-923-8719**.

Representatives are available to answer your questions Monday - Friday from 8:00 a.m. to 5:00 p.m. (CT) or visit the F.A.Q.'s at www.whistlergroup.com.

CORPORATE HEADQUARTERS

1716 SW Commerce Dr. Ste. 8

PO Box 1760

Bentonville, AR 72712

Toll Free (800) 531-0004

TEL (479) 273-6012

FX (479) 273-2927

www.whistlergroup.com

CUSTOMER RETURN CENTER

1412 South 1st St.

Rogers, AR 72756

Customer Service Tel (866) 923-8719

Email: info@whistlergroup.com

P/N 581003a

06C14 © 2014 The Whistler Group, Inc.